

Container

Rollcontainer

Standcontainer



Inhaltsverzeichnis

	Seite
Container _____	
Rollcontainer _____	Co 1
Standcontainer _____	Co 2
Einrichtungssets für Schubladen _____	Co 3

Unsere Container sind geprüft worden durch die Entwicklungs- Prüflabor Holztechnik GmbH,

die Prüfbescheinigung "GS" wurde erteilt.
gilt nur für Rollcontainer bis Höhe 58



Produktbeschreibung Container





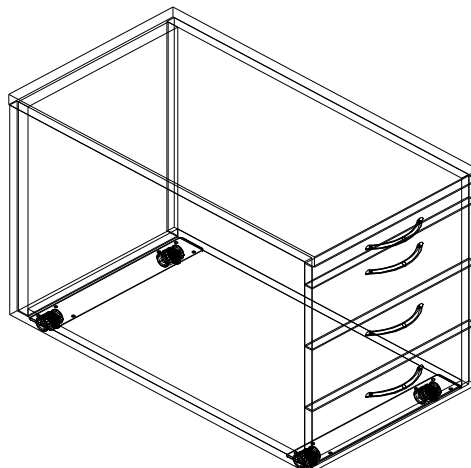

Beschreibung

Platte : - Material melaminharzbeschichtete E1 Spanplatte mit Kunststoffleimer (Oberbodenstärke 2,5 cm)





- Aufteilung in Höheneinheiten HE (1x HE = 5 cm)
 - 1 HE - Materialauszug mit Zentralverriegelung
 - 2/3/4 HE - Stahlschub auf 4/5 Kugelauszug + 1x Trennsteg (Tiefe 800 2x)
 - 6 HE - Stahlschub auf Vollkugelauszug mit Einstellhängerahmen A4
- Hebelzylinderschloss verschiedenschließend (serienmäßig), gleichschließend sowie Schließung nach Plan möglich
- Bügelgriff Bohrabstand 128mm ZW -chrom (serienmäßig)

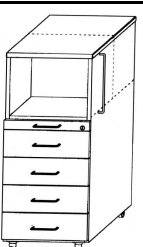







Rollcontainer

Beschreibung	B	T	H	Bestell-Nr.:	Preis :	Abbildung
Rollcontainer Aufteilung : 1 - 3 - 3 - 3 HE	43,4	60	58	631		
	43,4	80	58	611		
Rollcontainer Aufteilung : 1 - 2 - 3 - 4 HE	43,4	60	58	633		
	43,4	80	58	613		
Rollcontainer Aufteilung : 1 - 3 - 6 HE	43,4	60	58	731		
	43,4	80	58	711		
Rollcontainer Aufteilung : 1 - 2 - 3 - 3 HE	43,4	60	53	635		
	43,4	80	53	615		
Rollcontainer Aufteilung : 1 - 2 - 6 HE	43,4	60	53	735		
	43,4	80	53	715		
Rollcontainer Aufteilung : 1 - 3 - 4 HE	43,4	60	48	831		
	43,4	80	48	811		
Hochrollcontainer Aufteilung : 1 - 3 - 3 - 3 - 3 HE 1 - 3 - 3 - 6 HE 1 - 6 - 6 HE oben 1 OH mit Mittelwand	43,4	60	115	737		
	43,4	60	115	738		
	43,4	60	115	739		

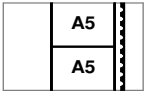
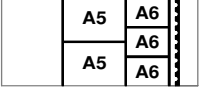
Standcontainer

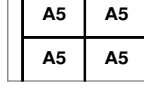
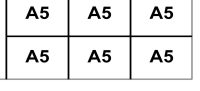
Beschreibung	B	T	H	Bestell-Nr.:	Preis :	Abbildung
Standcontainer Aufteilung : 1 - 3 - 3 - 3 - 3 HE inkl. Höhenversteller	43,4	60	72	581		
	43,4	80	72	561		
Standcontainer Aufteilung : 1 - 3 - 3 - 6 HE inkl. Höhenversteller	43,4	60	72	531		
	43,4	80	72	511		
Standcontainer Aufteilung : 1 - 6 - 6 HE inkl. Höhenversteller	43,4	60	72	431		
	43,4	80	72	411		
Standcontainer Aufteilung : 1 - 4 - 4 - 4 HE inkl. Höhenversteller	43,4	60	72	591		
	43,4	80	72	571		

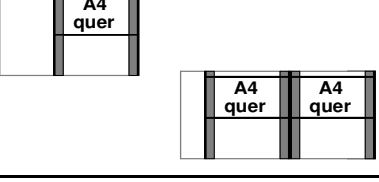
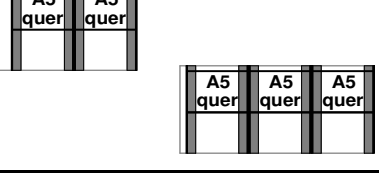
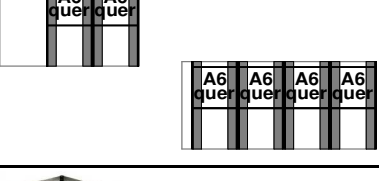
Einrichtungssets für Schubladen

Beschreibung :		T60	T80	T	Bestell-Nr.:	Preis :	Abbildung
Set 1				60	SET 1-60		
Stempelhalter	1 x	1 x					
Trennsteg	2 x	3 x					
Fachteiler DIN A6		2 x	80	SET 1-80			
Fachteiler DIN A5	1 x	1 x					
Set 2				60	SET 2-60		
Trennsteg	3 x	4 x					
			80	SET 2-80			
Set 3				60	SET 3-60		
Trennsteg	2 x	3 x					
Fachteiler DIN A5	2 x	3 x					
			80	SET 3-80			
Set 4 für 3 HE				60	SET 4-60		
Formularablagen	5 x	7 x					
			80	SET 4-80			
Set 5 für 6 HE				60	SET 5-60		
Formularablagen	9 x	14 x					
			80	SET 5-80			
Set 8 für 6 HE				60	SET 8-60		
Karteibahn	1 x	2 x					
Schwenkstütze (DIN A4 quer)	2 x	4 x					
			80	SET 8-80			
Set 9 für 4 HE				60	SET 9-60		
Karteibahn	2 x	3 x					
Schwenkstütze (DIN A5 quer)	4 x	6 x					
			80	SET 9-80			
Set 10 für 3 HE				60	SET 10-60		
Karteibahn	2 x	4 x					
Schwenkstütze (DIN A6 quer)	4 x	8 x					
			80	SET 10-80			
Hängerahmen				60	Z410		
1x Zwischensteg							
			80	Z400			
2x Zwischensteg							